



.....
ST3655 Family:

.....
ST3390A, ST3550A, ST3655A

.....
AT Interface Drives

.....
Product Manual

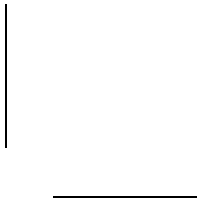
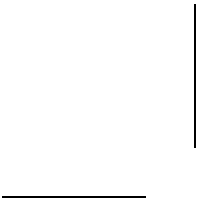

.....
ST3655 Family:
.....
ST3390A, ST3550A, ST3655A
.....
AT Interface Drives
.....

.....
Product Manual
.....



© 1993 Seagate Technology, Inc. All rights reserved
Publication Number: 36244-003, Rev. A
23 December 1993

Seagate®, Seagate Technology® and the Seagate logo are registered trademarks of Seagate Technology, Inc. Other product names are trademarks or registered trademarks of their owners.

Seagate reserves the right to change, without notice, product offerings or specifications. No part of this publication may be reproduced in any form without written permission from Seagate Technology, Inc.

Contents

1.0 Specifications	1
1.1 Formatted capacity	1
1.1.1 Recommended logical configuration	1
1.1.2 Physical organization	2
1.2 Functional specifications	2
1.3 Seek time	2
1.3.1 Thermal compensation	3
1.3.2 Multisegmented cache buffer	3
1.4 Start/stop time	4
1.5 Typical power-up and power-down sequence	4
1.5.1 Power-up sequence	4
1.5.2 Power-down sequence	4
1.5.3 Auto-park	4
1.6 Reliability	5
1.7 Physical dimensions	5
1.8 Environmental specifications	5
1.8.1 Ambient temperature	5
1.8.2 Temperature gradient	5
1.8.3 Altitude	5
1.8.4 Relative humidity	6
1.9 Acoustics	6
1.10 Shock and vibration	6
1.11 DC power	7
1.11.1 Input noise	7
1.11.2 Power management	7
1.11.3 Idle and standby timers	7
1.11.4 Power-management modes	8
1.11.5 Power consumption	9

1.12 Agency listings	11
1.13 FCC verification	11
2.0 Configuring and mounting the drive	13
2.1 Handling and static-discharge precautions	13
2.2 I/O cable and connector	14
2.3 Remote LED connection	15
2.4 Jumpers	15
2.4.1 Jumper sizes	15
2.4.2 Factory test jumper block (J6)	15
2.4.3 Master/slave configuration	17
2.5 Cable select option	18
2.6 Spindle synchronization option	20
2.7 Mounting the drive	22
3.0 AT interface	25
3.1 Command set	25
3.1.1 Identify Drive command (ECh)	27
3.1.2 Set Features command (EFH)	29
3.1.3 Sleep command (99H, E6H)	29
3.2 AT Interface connector pin assignments	29
Appendix. Timing diagrams	31

Figures

Figure 1. Typical startup current profile	10
Figure 2. AT interface connector	14
Figure 3. Configuration jumpers	16
Figure 4. Connecting cable-selected drives	19
Figure 5. Connecting synchronized drives	21
Figure 6. Spindle synchronization timing	21
Figure 7. Recommended mounting orientations	23
Figure 8. Mounting dimensions	24
Figure 9. AT interface connector pin assignments	30
Figure 10. Programmed I/O timing without IORDY	31
Figure 11. Programmed I/O timing with IORDY	32
Figure 12. Multiword DMA timing	33

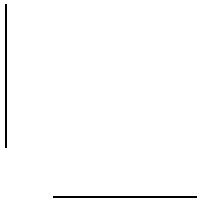
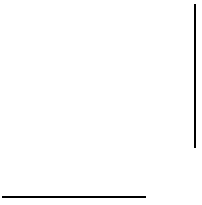

1.0 Specifications

1.1 Formatted capacity

The drive is low-level formatted at the factory. You cannot low-level format the drive.

	ST3390A	ST3550A	ST3655A
Formatted capacity (Mbytes*)	341.311	452.415	528.482
Total sectors	666,624	883,624	1,032,192

* One megabyte equals one million bytes.

1.1.1 Recommended logical configuration

You can operate the drive using many different logical configurations, provided the number of sectors per track does not exceed 256. However, in DOS the number of sectors per track must be less than or equal to 63. When establishing the logical configuration, set the number of sectors per track and the number of heads to satisfy the following relationship:

$$16 \leq (\text{sectors per track})(\text{heads}) \leq 4,096$$

When you configure the drive in CMOS, the total sectors cannot exceed the physical capacity of the drive. The total sectors is determined by the following formula:

$$\text{total sectors} = (\text{logical heads}) (\text{logical sectors per track}) (\text{logical cylinders})$$

To maximize the capacity of the drive, the following geometry is recommended:

	ST3390A	ST3550A	ST3655A
Cylinders	768	1,018	1,024
Read/write heads	14	14	16
Sectors per track	62	62	63

The drive is configured in translation mode. You can verify the number of cylinders, sectors per track and heads by using the Identify Drive (ECH) command. See Section 3.1.1 for details about the Identify Drive command.

1.1.2 Physical organization

	ST3390A	ST3550A	ST3655A
Read/write heads	3	5	5
Servo heads	1	1	1
Discs	2	3	3

1.2 Functional specifications

Interface	AT
Zone Bit Recording method	RLL (1,7)
External data burst transfer rate (Mbytes per sec)	11.1*
Internal data transfer rate (Mbits per sec)	21.6 to 36.56
Spindle speed (RPM)	4,500 ± 0.5%
Cache size (Kbytes)	256
Bytes per sector	512
Recording density, max (BPI)	53,192**
Track density (TPI)	3,000**

* The drives achieve this external transfer rate when using programmed I/O with IORDY, as shown in Figure 11 on page 32.

** The ST3550A has a recording density of 52,602 bits per inch and a track density of 2,400 tracks per inch.

1.3 Seek time

Seek time is a true statistical average of at least 5,000 measurements of seek time. All measurements are under nominal conditions of temperature and voltage with the drive mounted horizontally. The specifications in the table below are defined as follows:

- Track-to-track seek time is the average of all possible single-track seeks in both directions.
- Average seek time is measured by executing seeks in both directions between random cylinders.
- Full-stroke seek time is half the time needed to seek from track 0 to the maximum track and back to track 0.

Track-to-track seek time	Average seek time	Full-stroke seek time	Average latency
3.5 msec typ 4.0 msec max	12.0 msec typ 14.0 msec max	30.0 msec typ 32.0 msec max	6.67 msec

Note. Host overhead varies between systems and cannot be specified. Drive internal overhead is measured by issuing a no-motion seek. Overhead is typically less than 0.5 msec.

1.3.1 Thermal compensation

The thermal compensation feature compensates for position offset of the selected head because of variations in temperature. The drive automatically compensates for thermal offset every 30 seconds for the first 30 minutes of operation and every 1.5 minutes thereafter. The drive performs this automatic compensation while executing a command from the computer.

You can pre-empt the automatic compensation by issuing a Recalibrate command. The drive performs a thermal compensation, sets a timer and waits 2 minutes before performing the automatic compensation again.

Thermal compensation increases the execution time of the command during which it is performed by 100 msec (typ) to 350 msec (max).

1.3.2 Multisegmented cache buffer

The drive uses the cache buffer to improve performance by eliminating access times under certain conditions. The cache buffer contains four 64-Kbyte segments of RAM (one for writing and three for reading) for a total capacity of 256 Kbytes.

Read look-ahead. The drive uses the read segments to store additional logical sectors, after the last requested sector, into a buffer before the additional sectors are requested by the computer. The cache buffer stores data from the start of a read until the buffer segment is full, or until another command is received from the computer.

Write immediate. The drive uses the write segment to store write commands and data. After the drive receives all the data for the command, it issues a write complete. Then, the drive writes the data to the disc.

Write merging. The drive accepts contiguous write commands and executes them as one command.

1.4 Start/stop time

Within 20 seconds after DC power is applied, the drive is ready. Within 15 seconds after DC power is removed, the drive spindle stops rotating.

1.5 Typical power-up and power-down sequence

The typical power-up and power-down sequences assist you in evaluating the drive's performance; they are not performance specifications.

1.5.1 Power-up sequence

1. Power is applied to the drive.
2. When power is applied, the LED is on for about 1 second.
3. The spindle motor reaches operating speed in about 4 seconds.
4. The arm-lock solenoid releases the arm, making an audible sound.
5. The drive performs velocity adjustment seeks.
6. The heads are positioned over track 0 and the drive is ready.

1.5.2 Power-down sequence

Caution. Do not move the drive until the motor has come to a complete stop.

1. The power is turned off.
2. Within 3 seconds, the motor begins to spin down.
3. The read/write heads automatically move to the shipping zone, which is inside the maximum data cylinder.
4. The arm-lock solenoid locks the arm, making an audible sound. This completes the power-down sequence.

1.5.3 Auto-park

Upon power-down, the read/write heads automatically move to the shipping zone. The heads park inside the maximum data cylinder and the arm-lock solenoid engages, making an audible sound. When power is applied, the heads recalibrate to track 0.

1.6 Reliability

Read error rates are measured with automatic retries and data correction with ECC enabled and all flaws re-allocated. The mean time between failures (MTBF) is measured at nominal power at sea level and an ambient temperature of 40°C.

Nonrecoverable read errors	1 per 10 ¹³ bits transferred
Seek errors	1 per 10 ⁷ physical seeks
MTBF	250,000 power-on hours
Service life	5 years

1.7 Physical dimensions

The mounting dimensions are shown in Figure 8 on page 24.

Height, max	1.00 inch (25.4 mm)
Width, max	4.02 inches (102.1 mm)
Depth, max	5.77 inches (146.6 mm)
Weight	1.5 lb (0.68 Kg)

1.8 Environmental specifications

1.8.1 Ambient temperature

Operating	5°C to 55°C (41°F to 131°F)
Nonoperating	-40°C to 65°C (-40°F to 149°F)

1.8.2 Temperature gradient

Operating	20°C per hour (36°F per hour)
Nonoperating	30°C per hour (54°F per hour)

1.8.3 Altitude

Operating	-1,000 ft to 10,000 ft (-305 m to 3,048 m)
Nonoperating	-1,000 ft to 40,000 ft (-305 m to 12,192 m)

1.8.4 Relative humidity

Operating	8% to 80% noncondensing Maximum wet bulb 26°C (79°F)
Maximum operating gradient	10% per hour
Nonoperating	5% to 95% noncondensing Maximum wet bulb 26°C (79°F)

1.9 Acoustics

Sound pressure is measured from 1 meter above the drive top cover at idle.

Sound pressure, typ (dBA)	34
Sound pressure, max (dBA)	38

1.10 Shock and vibration

All shock and vibration specifications assume that the drive is mounted in a recommended orientation (see Figure 7 on page 23) with the input levels measured at the drive mounting screws. Shock measurements are based on an 11 msec, half sine wave shock pulse, not to be repeated more than twice per second.

During normal operating shock and vibration, there is no physical damage to the drive or performance degradation. During nonoperating shock and vibration, the read/write heads are positioned in the shipping zone.

	Operating	Nonoperating
Shock	2 Gs	75 Gs
5–22 Hz vibration	0.020-inch displacement	0.020-inch displacement
22–500 Hz vibration	0.50 Gs	4.00 Gs

1.11 DC power

Except during the write procedure, you can turn off and turn on power to the drive in any sequence without losing data or damaging the drive. If you turn off the power during the write procedure, you may lose the data currently being written.

1.11.1 Input noise

	+5V	+12V
Voltage tolerance (including noise)	± 5%	± 5%
Input noise frequency (max)	25 MHz	25 MHz
Input noise (max, peak-to-peak)	100 mV	240 mV

1.11.2 Power management

This drive uses power-management modes to reduce its overall power consumption. The level of drive activity for each power-management mode is described below.

You can customize the power-management modes using the AT interface commands that control the power modes. These commands are described in the *Seagate ATA Interface Reference Manual*, publication number 36111-xxx.

Note. If you install one of these power-management drives as a slave to a master drive that does not support power management (for example, a Seagate ST1239A drive), do not use power-management commands on either drive.

1.11.3 Idle and standby timers

The drive can enter the Idle or Standby modes by either of two methods:

- The computer can send either the Idle Immediate command or the Standby Immediate command.
- The idle timer or the standby timer can count down to zero.

At power-on, the drive sets the idle timer to enter the Idle mode after 5 seconds of inactivity; the standby timer is disabled. You can set the timer delays using the system setup utility. During each read, write or

seek, the drive reinitializes the idle timer and begins counting down from the specified delay to zero.

If the idle timer reaches zero before the drive is commanded to read, write or seek, the drive switches to the Idle mode. Then, if the standby timer is enabled, the standby timer begins counting down. After the standby timer has finished counting down, the drive switches to Standby mode. To set the idle and standby timers, refer to the Idle command in the *Seagate ATA Interface Reference Manual*, publication number 36111-xxx.

In both the Idle and Standby modes, the drive accepts all commands and returns to the Seeking or Read/write modes any time disc access is necessary.

1.11.4 Power-management modes

The following power-management modes are supported by the drive:

- **Spinup.** The drive brings the spindle and discs up to operating speed. Power in this mode is defined as the average power during the first 10 seconds after starting spinup. The drive enters this mode during startup and from the Standby mode.
- **Seeking.** The drive moves the read/write heads to a specific location on the disc surface in preparation for reading or writing the disc. Read/write electronics are powered down and servo electronics are active. The power measure during this mode is the average power while executing random seeks with a 2-revolution (26.6 msec) dwell between Seek commands.
- **Read/write.** The drive reads or writes the disc. Read/write electronics are active and the servo is on track. The drive enters this mode from the Idle mode.
- **Idle.** The spindle is spinning and the cache buffer remains enabled, and the drive accepts all commands and returns to the Seeking or Read/write modes when it receives a command that requires disc access.
- **Standby.** The spindle is stopped, the heads are parked in the landing zone, the actuator is latched, and some of the drive electronics are powered down. The drive reports to the computer that it is ready to access the disc. When the drive receives a command that does not require disc access, the drive remains in the Standby mode. When the drive receives a command that requires disc access, it spins up and performs the command.

1.11.5 Power consumption

In the table below, the values apply at the drive power connector. Current was measured with an RMS DC ammeter.

	Spinup	Seeking	Read/ write	Idle	Standby
Current at +12V					
Amps peak	1.90	—	—	—	—
RMS amps typ	—	0.408	0.241	0.208	0.025
Watts typ	—	4.90	2.90	2.50	0.30
Current at +5V					
RMS amps typ	—	0.140	0.500	0.130	0.120
Watts typ	—	0.70	2.50	0.65	0.60
Power					
Total watts typ	7.00	5.60	5.40	3.15	0.90

The startup current profile of each drive is unique. A typical startup current profile is shown in Figure 1.

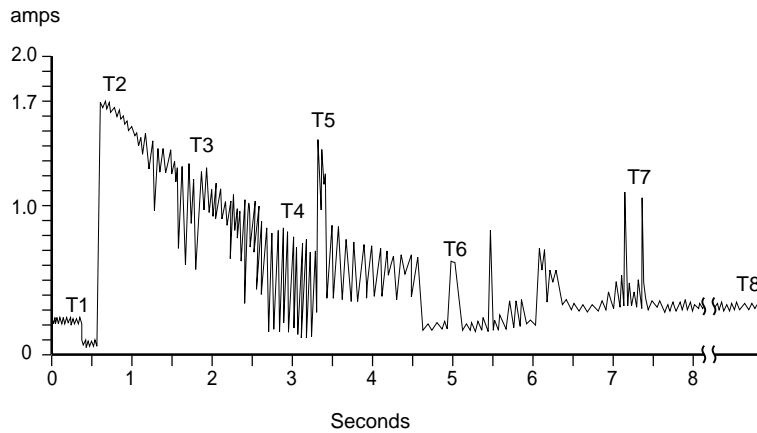

Figure 1. Typical startup current profile

- T1 Power is applied to the drive.
- T2 After a delay, the startup current is applied and the spindle begins to turn.
- T3 The accelerating current is applied, causing the spindle speed to increase.
- T4 The spindle speed is close to the final correct value. The drive begins to lock in speed-control circuits.
- T5 The arm-lock solenoid releases the arm.
- T6 The final speed-control lock is achieved.
- T7 The drive performs velocity adjustment seeks.
- T8 The heads are positioned over track 0, and the drive is ready.

1.12 Agency listings

This drive is listed by agencies as follows:

- Recognized in accordance with UL 478 and UL 1950
- Certified to CSA C22.2 No. 220-M1986 and CSA C22.2 No. 950
- Certified to VDE 0805/05.90 and EN 60950/1.88 as tested by VDE

1.13 FCC verification

ST3655 family AT interface drives are intended to be contained solely within a personal computer or similar enclosure (not attached to an external device). As such, a drive is considered to be a subassembly even when individually marketed to the customer. As a subassembly, no Federal Communications Commission authorization, verification or certification of the device is required.

Seagate Technology, Inc. has tested these drives in an enclosure as described above to ensure that the total assembly (enclosure, disc drive, motherboard, power supply, etc.) does comply with the limits for a Class B computing device, pursuant to Subpart J of Part 15 of the FCC rules. Operation with noncertified assemblies is likely to result in interference to radio and television reception.

Radio and television interference. This equipment generates and uses radio frequency energy and, if not installed and used in strict accordance with the manufacturer's instructions, may cause interference to radio and television reception.

This equipment is designed to provide reasonable protection against such interference in a residential installation. However, there is no guarantee that interference will not occur in a particular installation. If this equipment does cause interference to radio or television, which can be determined by turning the equipment on and off, you are encouraged to try one or more of the following corrective measures:

- Reorient the receiving antenna.
- Move the device to one side or the other of the radio or TV.
- Move the device farther away from the radio or TV.
- Plug the equipment into a different outlet so that the receiver and computer are on different branch outlets.

If necessary, you should consult your dealer or an experienced radio/television technician for additional suggestions. You may find helpful the following booklet prepared by the Federal Communications Commission: *How to Identify and Resolve Radio-Television Interference Problems*. This booklet is available from the Superintendent of Documents, US Government Printing Office, Washington, DC 20402. Refer to publication number 004-000-00345-4.

Note. This digital apparatus does not exceed the Class B limits for radio noise emissions from computer equipment as set out in the radio interference regulations of the Canadian Department of communications.

Le présent appareil numérique n'émet pas de bruits radioélectriques dépassant les limites applicables aux appareils numériques de Classe B prescrites dans le règlement sur le brouillage radioélectrique édicté par le Ministère des Communications du Canada.

Sicherheitsanleitung

1. Das Gerrät ist ein Einbaugerät, das für eine maximale Umgebungs-temperatur von 55°C vorgesehen ist.
2. Zur Befestigung des Laufwerks werden 3 Schrauben 6-32 UNC-2A benötigt. Bei seitlicher Befestigung darf die maximale Länge der Schrauben im Chassis nicht mehr als 3,3 mm und bei Befestigung an der Unterseite nicht mehr als 5,08 mm betragen.
3. Als Versorgungsspannungen werden benötigt:
+5V \pm 5% 0,5A
+12V \pm 5% 0,5A (1,9A für ca. 30 Sek. für \pm 10%)
4. Die Versorgungsspannung muß SELV entsprechen.
5. Alle Arbeiten dürfen nur von ausgebildetem Servicepersonal durchgeführt werden.
6. Der Einbaudes Drives muß den Anforderungen gemäß DIN IEC 950V DC 0805/05.90 entsprechen.

2.0 Configuring and mounting the drive

This section contains the specifications and instructions for configuring and mounting the drive.

2.1 Handling and static-discharge precautions

After you unpack the drive, and before you install it in a system, be careful not to damage it through mishandling. Observe the following standard handling and static-discharge precautions:

Caution:

- Keep the drive in its static-shielded bag until you are ready to complete the installation. Do not attach any cables to the drive while it is in its static-shielded bag.
- Before handling the drive, put on a grounded wrist strap, or ground yourself frequently by touching the metal chassis of a computer that is plugged into a grounded outlet. Wear a grounded wrist strap throughout the entire installation procedure.
- Handle the drive by its edges or frame only.
- The drive is extremely fragile—handle it with care. Do not press down on the drive top cover.
- Always rest the drive on a padded, antistatic surface until you mount it in the computer.
- Do not touch the connector pins or the printed circuit board. Do not touch the printed circuit cable between the circuit board and the head/disc assembly.
- Avoid wool or synthetic clothing, carpeting, plastics, and Styrofoam; these items cause static discharge.
- Do not remove the factory-installed labels from the drive or cover them with additional labels. If you do, you void the warranty. Some factory-installed labels contain information needed to service the drive. Others are used to seal out dirt and contamination.

2.2 I/O cable and connector

The I/O connector is a 40-pin connector. The even pins are next to the edge of the printed circuit board; the odd pins are away from the printed circuit board. Pin 1 is near the 4-pin power connector. The I/O connector is shown in Figure 2.

There is no pin 20 because that location is used as a key. Make sure the corresponding pin hole on the cable connector is plugged to prevent the connector from being installed upside down. The I/O cable cannot be longer than 18 inches (0.46 meters).

The table below lists recommended parts for the mating connector. You can use equivalent parts.

Part	Description	3M part number
Connector	40-pin	3M-3417-7000
Connector	40-pin	3M-3448-2040
Flat cable	AWG28 (stranded)	3M-3365-40

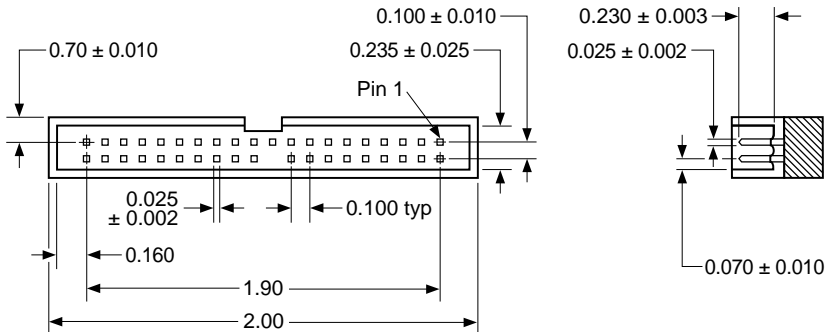

Figure 2. AT interface connector

2.3 Remote LED connection

To add an optional remote LED, attach a two-pin, 0.1-inch connector to pins 13 and 14 of the options jumper block.

2.4 Jumpers

You can connect two drives to a daisy-chain cable if both drives meet the same interface specifications. In a dual-drive configuration, one drive is designated as the master (drive 0) and the other as the slave (drive 1). See Figure 3 on page 16 for jumper settings.

If you intend to use either the cable select option or the spindle synchronization option in a dual-drive system, you should determine which of these options your system supports before continuing. See your computer documentation for details. These options are described in more detail in Sections 2.5 and 2.6.

2.4.1 Jumper sizes

The jumper blocks use 0.1-inch configuration jumpers. Use Seagate part number 10562-001 or an equivalent.

Caution. If you try to install a jumper that is not the correct size, you could damage the jumper and the jumper block pins.

2.4.2 Factory test jumper block (J6)

The pins on this jumper block are used for testing during the manufacturing process; do not install jumpers on them.

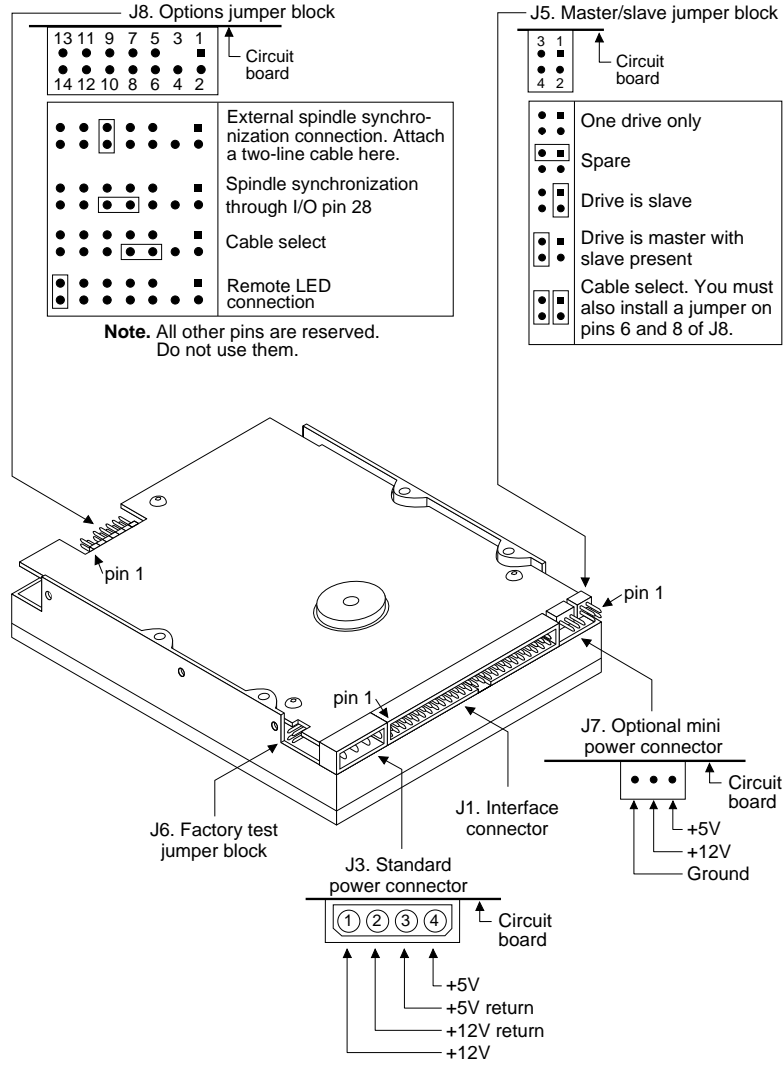

Figure 3. Configuration jumpers

2.4.3 Master/slave configuration

Your drive is shipped with a jumper installed in a spare location on pins 1 and 3 of the master/slave jumper block. If you are installing only one drive, you can leave the jumper installed on pins 1 and 3, or you can remove all jumpers from the jumper block.

You can install up to two drives in a standard AT system. If you are installing two drives in your system, configure one drive as the master and the other as the slave according to the following guidelines:

- To configure the drive as a master with a slave present, install a jumper on pins 3 and 4 only of the master/slave jumper block of the master drive.

Note. If both the master and the slave are ST3655 family drives, you do not need to install a jumper on pins 3 and 4. This is because the master can detect the presence of the slave using the DASP– signal on the AT interface cable. If the drives in your application do not implement the DASP– signal, install the jumper on pins 3 and 4 of the master/slave jumper block on the master drive only.

- To configure the drive as a slave, install a jumper on pins 1 and 2 only of the master/slave jumper block on the slave drive.

With the aid of a special interface ribbon cable, the cable select option allows you to determine the master and slave according to where the drives are plugged in the cable. Cable select is described in more detail in Section 2.5.

Note. Early ST3655 family drives do not support the cable select option. To use cable select on an ST3550A, your circuit board part number must be 260058-109 or 260100-xxx. To use cable select on an ST3390A or an ST3655A, your circuit board part number must be 260124-xxx.

2.5 Cable select option

If your computer and both of your drives support cable select, you can use the cable select option to determine the master and slave, according to the following guidelines, which are illustrated in Figure 4.

- The drive plugged into the I/O connector that carries the CSEL signal is the master.
- The drive plugged into the I/O connector that does not carry the CSEL signal is the slave.

To configure your drives using cable select, you need to:

- Install jumpers on pins 1 and 2 and pins 3 and 4 of the master/slave jumper block and pins 6 and 8 of the options jumper block. These jumper blocks are both shown in Figure 3 on page 16.
- Use a special interface ribbon cable to select master and slave. The cable and its connectors transmit the CSEL signal (pin 28) to the master drive, but not to the slave drive, as shown in Figure 4.

Note. You cannot configure the drive for both cable select and spindle synchronization at the same time because both options use the same interface signal line (pin 28) and the same jumper block pin (pin 8 of the options jumper block).

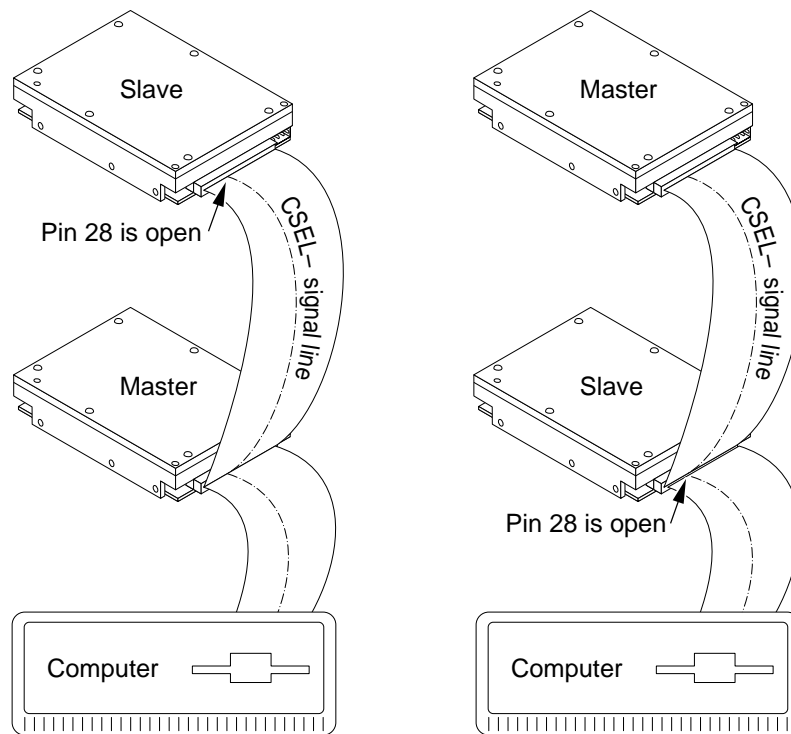

Figure 4. Connecting cable-selected drives

Note. Early ST3655 family drives do not support the cable select option. To use cable select on an ST3550A, your circuit board part number must be 260058-109 or 260100-xxx. To use cable select on an ST3390A or an ST3655A, your circuit board part number must be 260124-xxx.

2.6 Spindle synchronization option

If your computer and all of your drives support the spindle synchronization option, you can use the spindle synchronization to synchronize up to 12 drive spindles to the spindle clock signal (SPSYNC-).

Note. You cannot configure the drive for both spindle synchronization and cable select at the same time because both options use the same interface signal line (pin 28) and the same jumper block pin (pin 8 of the options jumper block). If you are using cable select, skip this section.

When two or more drives are connected to the computer, the drives automatically configure themselves for spindle synchronization in either of two ways:

- The spindle synchronization clock signal is generated by the computer. The drives configure themselves as slaves and synchronize their spindles according to the computer signal.
- The spindle synchronization clock signal is generated by one of the drives. The master configures itself as the originator of the SPSYNC- signal; the other drives become slaves, or receivers, of the SPSYNC- signal.

The slave receives the signal to synchronize its spindle with the computer or master and synchronizes its index with the SPSYNC- signal. Synchronization is achieved, and is indicated by the drive setting DRDY. (If a drive that was already synchronized loses synchronization, but continues to function, it does not clear DRDY.)

There are two ways to enable spindle synchronization:

- Enable pin 28 (SPSYNC-) of the AT interface connector by installing a jumper on pins 8 and 10 of the options jumper block.
- Connect a twisted pair to pins 9 and 10 of the options jumper block to transmit and receive SPSYNC-.

Use one strand of the twisted pair cable to connect pin 9 of the options jumper block of each drive. Use the other strand to connect pin 10 of the options jumper block of each drive. Use a 2-mm connector. The cable should not be longer than six feet (1.8 meters). Figure 5 shows you how to connect synchronized drives.

The spindle clock uses a single-ended TTL, active low, 75-Hz signal with a clock period of $13.34 \text{ msec} \pm 0.5\%$ and a duty cycle of 0.5 μsec minimum, 500 μsec maximum. The spindle-clock leading edge to index leading edge is $0 \pm 250 \mu\text{sec}$. Figure 6 shows the spindle-clock timing.

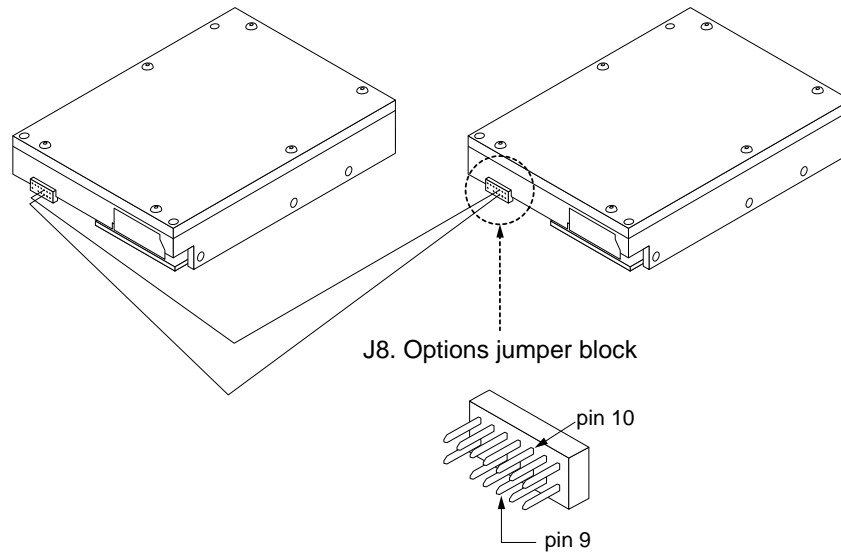

Figure 5. Connecting synchronized drives

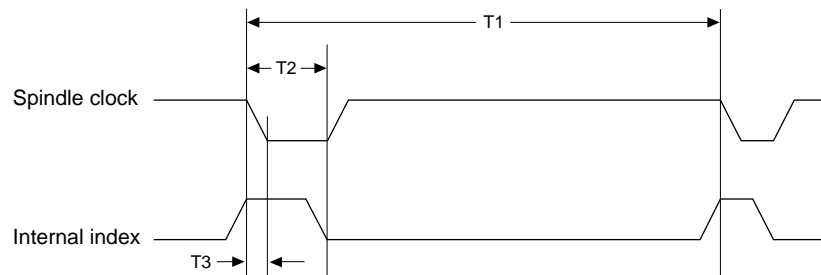

Figure 6. Spindle synchronization timing

T1	spindle clock period	13.34 msec \pm 0.5%
T2	duty cycle	0.5 μ sec minimum to 500 μ sec maximum
T3	spindle clock leading edge to index leading edge	0 μ sec \pm 250 μ sec

2.7 Mounting the drive

You can mount the drive in any orientation. For optimum performance, format the drive in the same orientation as you mount it in the computer.

Follow the guidelines below appropriate to the set of mounting holes you elect to use: either bottom mounting holes or side mounting holes. Refer to Figure 7 for the recommended mounting orientations. Refer to Figure 8 on page 24 for mounting dimensions.

Bottom mounting holes. Insert three 6-32 UNC screws in the three available bottom mounting holes as shown in Figure 7.

Caution. Do not insert the bottom mounting screws more than 0.20 inches (6 turns) into the drive frame. If you use a screw that is too long, you could damage the drive.

Side mounting holes. Use three 6-32 UNC screws in three of the six available side mounting holes as shown in Figure 7. Use two mounting holes on each side of the drive.

Caution. Do not insert the bottom mounting screws more than 0.13 inches (4 turns) into the drive frame. If you use a screw that is too long, you could damage the drive.

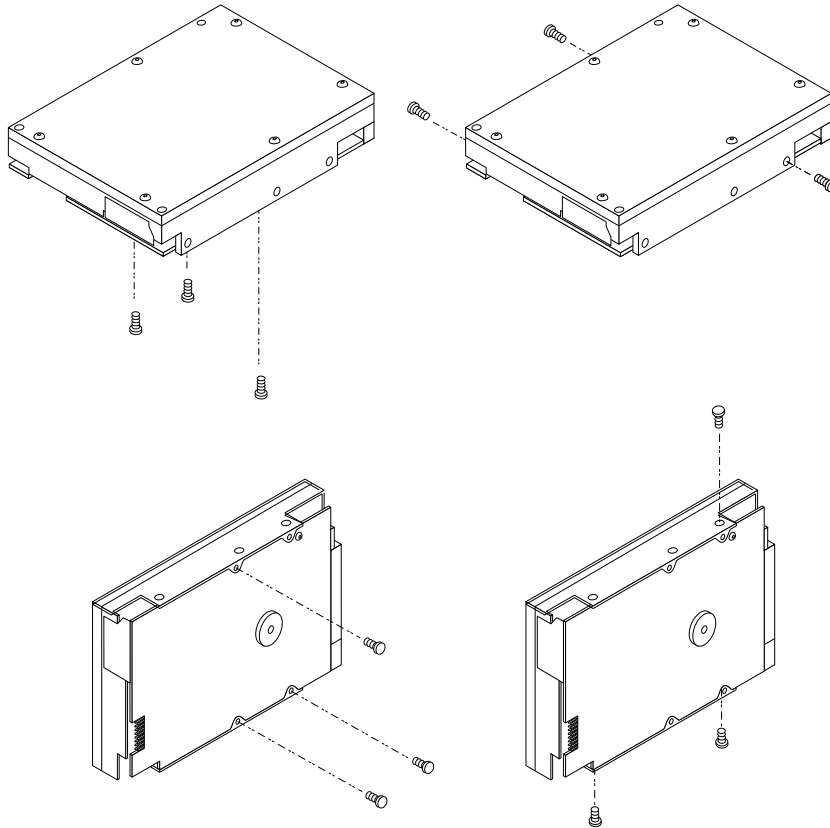

Figure 7. Recommended mounting orientations

In the following figure, all dimensions are in inches (mm).

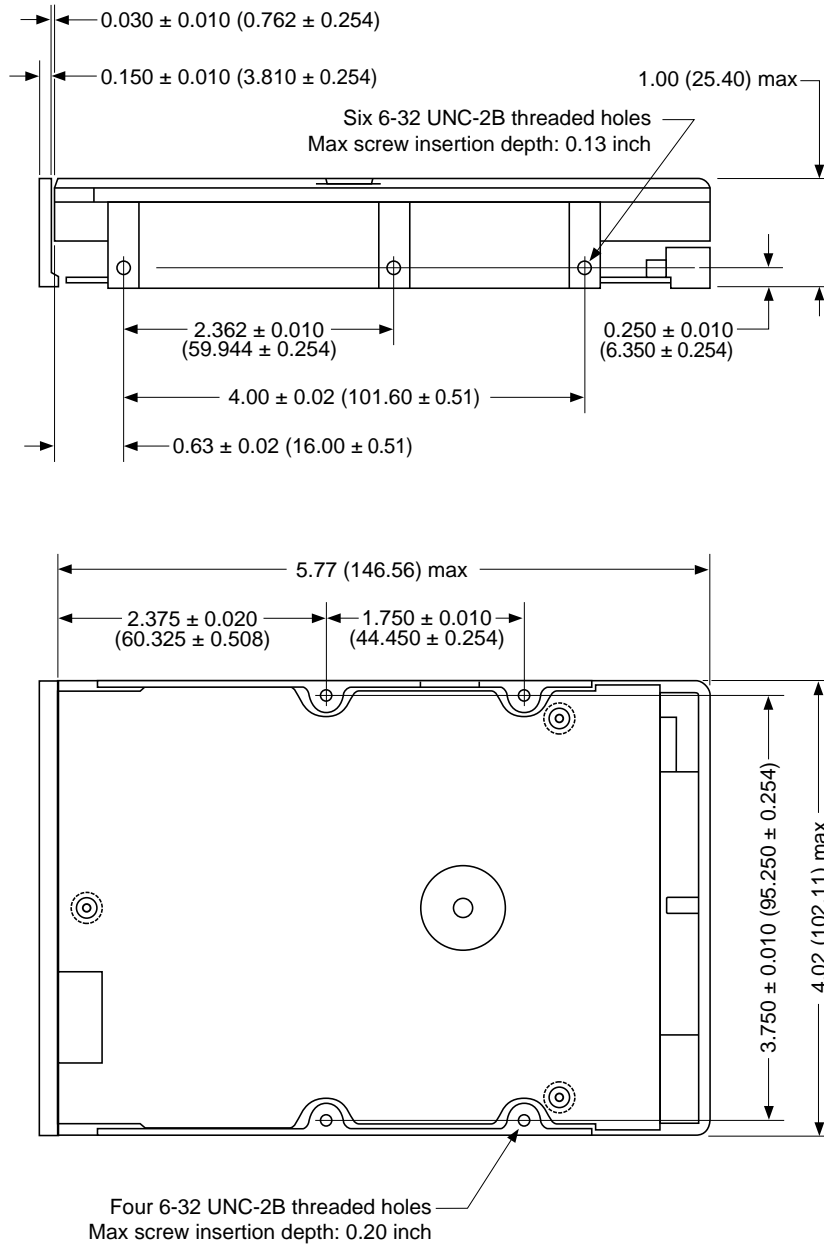

Figure 8. Mounting dimensions

3.0 AT interface

The AT interface implemented on these drives is compatible with the requirements of the IBM AT bus. The AT interface consists of single-ended, TTL-compatible receivers and drivers communicating through a 40-conductor flat-ribbon, nonshielded cable with a maximum length of 18 inches (0.46 meters) using an asynchronous interface protocol. The drivers can sink up to 24 mA and drive a load up to 300 pF.

3.1 Command set

The following table lists all commands implemented on the ST3655 family AT interface drives. For a complete description of all AT interface commands, refer to the *Seagate ATA Interface Reference Manual*, publication number 36111-xxx. The table uses the following abbreviations:

- FR Features register
- SN Sector number register
- DH Drive/head register
- SC Sector count register
- CY Cylinder register
- n This register does not contain a valid parameter for this command.
- y This register contains a valid parameter for this command. In the drive/head register, both the drive and head parameters are valid for this command.
- D The drive/head register contains a valid drive parameter for this command. The head parameter is not valid for this command.

Command name	Command code (in hex)	Parameters used				
		FR	SC	SN	CY	DH
Active and Set Idle Timer	FB	n	y	n	n	D
Active Immediate	F9	n	n	n	n	D
Check Idle Mode	FD	n	y	n	n	D
Check Power Mode	98, E5	n	y	n	n	D
Execute Drive Diagnostics	90	n	n	n	n	D

continued

continued from previous page

Command name	Command code (in hex)	Parameters used				
		FR	SC	SN	CY	DH
Format Track	50	n	y	n	y	y
Identify Drive	EC	n	n	n	n	D
Idle	97, E3	n	y	n	n	D
Idle and Set Idle Timer	FA	n	y	n	n	D
Idle Immediate	95, F8, E1	n	n	n	n	D
Initialize Drive Parameters	91	n	y	n	n	y
Read DMA	C8, C9	—	y	y	y	y
Read Long	22, 23	n	y	y	y	y
Read Multiple	C4	n	y	y	y	y
Read Sector	20, 21	n	y	y	y	y
Read Sector Buffer	E4	n	n	n	n	D
Read Verify Sector	40, 41	n	y	y	y	y
Recalibrate	1X	n	n	n	n	D
Seek	7X	n	n	y	y	y
Set Features	EF	y	n	n	n	D
Set Multiple Mode	C6	n	y	n	n	D
Sleep	99, E6	n	n	n	n	D
Standby	96, E2	n	n	n	n	D
Standby Immediate	94, E0	n	n	n	n	D
Write DMA	CA, CB	—	y	y	y	y
Write Long	32, 33	n	y	y	y	y
Write Multiple	C5	n	y	y	y	y
Write Sector	30, 31	n	y	y	y	y
Write Sector Buffer	E8	n	n	n	n	D

3.1.1 Identify Drive command (ECH)

The sector buffer parameters for these drives are listed in the table below. The *Seagate ATA Interface Reference Manual*, publication number 36111-xxx, describes the Identify Drive command in detail.

Word	Description	Value
0	Configuration	347AH
		2000H Track offset option available
		1000H Data strobe offset option available
		0400H Disc transfer rate > 10 Mbytes per second
		0040H Fixed drive
		0020H Spindle motor control option implemented
		0010H Head switch time > 15 μ sec
		0008H Not MFM encoded
		0002H Hard sectored
		1
2	Reserved	0
3	Default heads	See page 1
4	Bytes per track	36540
5	Bytes per sector	580
6	Default sectors per track	See page 1
7–9	Vendor-unique	0
10–19	Serial number	Drive-unique
20	Buffer type	3
21	Buffer size/512	512
22	ECC bytes (R/W Long)	4
23–26	Firmware revision	Drive-dependent
27–46	Model number	Drive-dependent
47	Sectors per R/W Multiple command	8040H R/W Multiple supported; 64 sectors/block
48	Double word I/O	0000H
49	Capabilities	0901H IORDY, DMA supported

Word	Description	Value
50	Reserved	0
51	PIO timing mode	0200H
52	DMA timing mode	0200H
53	Current valid	0003H, 54–58, 64–70 valid
54	Current cylinders	Drive-unique
55	Current heads	Drive-unique
56	Current sectors per track	Drive-unique
57–58	Current sectors	Drive-unique
59	Current multiple mode	0000H
60–61	LBA total sectors	0
62	Single-word DMA	0000H No modes are active; no modes are supported.
63	Multiword DMA	0103H Mode 0 is active; modes 0 and 1 are supported.
64	Advanced PIO	0001H Mode 3 is supported.
65	Minimum multiword DMA transfer per word	180 nsec
66	Recommended multiword DMA transfer per word	180 nsec
67	Minimum PIO transfer without IORDY	360 nsec
68	Minimum PIO transfer with IORDY	180 nsec
69– 127	Reserved	0
128– 159	Vendor-unique	x

Two commands that are described in the *Seagate ATA Interface Reference Manual* require further elaboration. These commands are described below.

3.1.2 Set Features command (EFH)

The Set Features command is used to enable or disable the Read Look-ahead, write immediate and write merging features. These features are enabled during startup. The values used in the features register are listed below:

- 02H Enable write immediate and write merging
- 55H Disable cache
- 82H Disable write immediate and write merging
- AAH Enable cache
- 03H Set transfer mode

3.1.3 Sleep command (99H, E6H)

This command performs the same function as the Standby command.

3.2 AT Interface connector pin assignments

The signal name and signal direction for each I/O connector pin is described in Figure 9 on page 30. See the *Seagate ATA Interface Reference Manual*, publication number 36111-xxx, for a complete description of each pin.

Signal names are in upper case. If the signal name is followed by a minus sign (-), the signal is active low. Otherwise, the signal is active high.

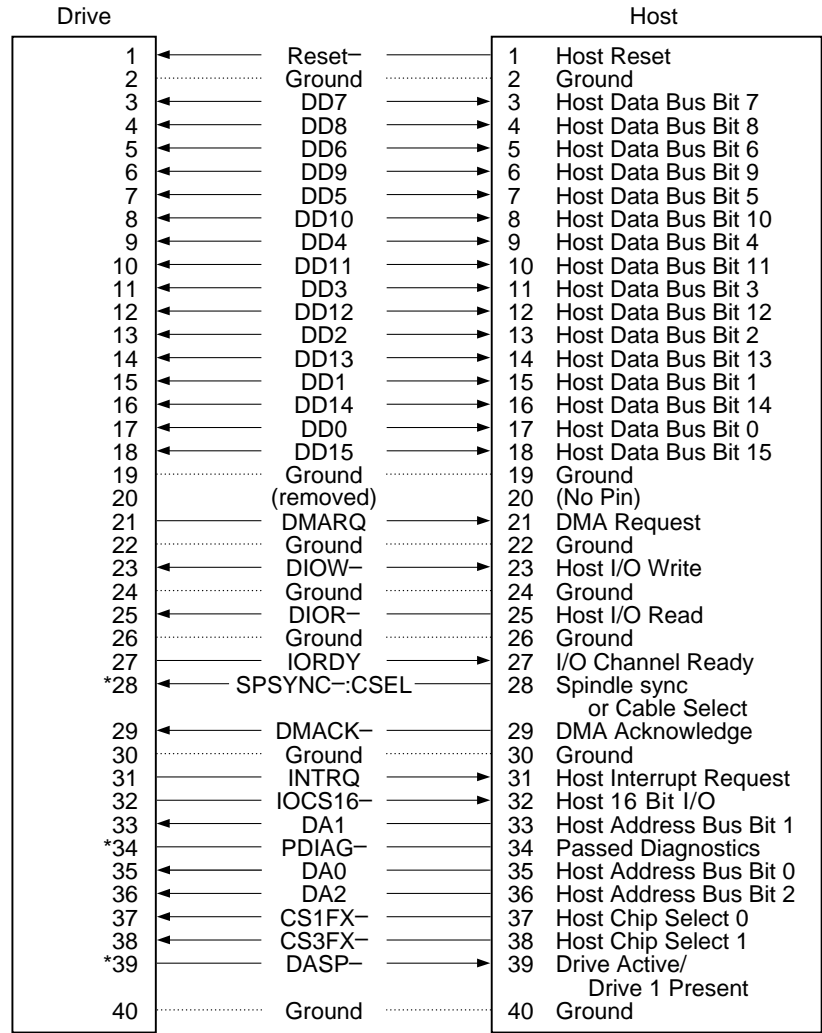

*Drive-to-drive signals

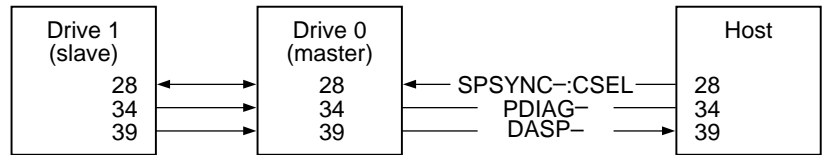

Figure 9. AT interface connector pin assignments

Appendix. Timing diagrams

Without IORDY, the drive operates at mode 3 programmed I/O timing specifications, as shown below.

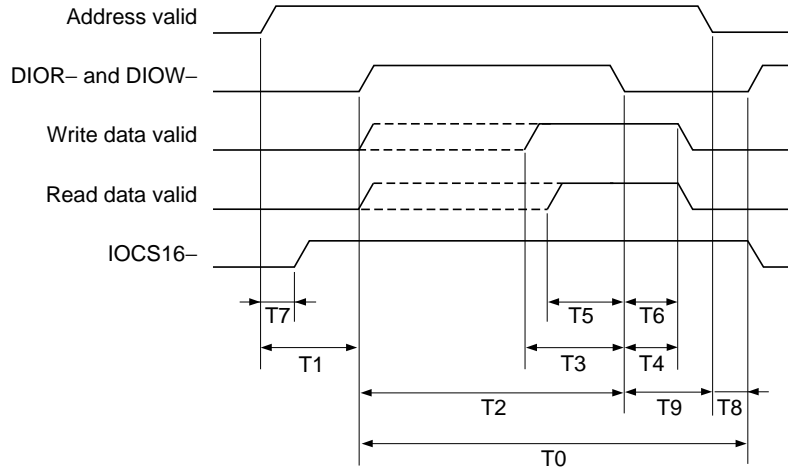

Figure 10. Programmed I/O timing without IORDY

Time	Description	Min	Max
T0	Cycle time	360 nsec	—
T1	Drive address (CS1FX-, CS3FX-, DA0, DA1 and DA2) valid and DIOR-/DIOW- setup	30 nsec	—
T2	DIOW- or DIOR- pulse width	80 nsec	—
T3	DIOW- data setup	30 nsec	—
T4	DIOW- data hold	15 nsec	—
T5	DIOR- data setup	20 nsec	—
T6	DIOR- data hold	5 nsec	—
T7	DIOW- or DIOR- to address valid hold	—	40 nsec
T8	DIOW- false to write data hold	—	30 nsec
T9	DIOR- false to read data hold	10 nsec	—

When using IORDY, the drive operates at mode 3 programmed I/O timing specifications, as shown below.

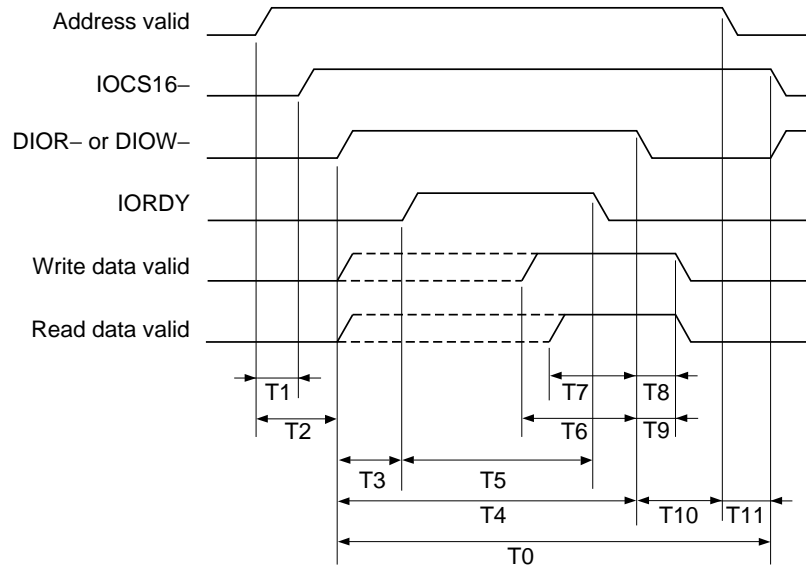

Figure 11. Programmed I/O timing with IORDY

Time	Description	Min	Max
T0	Cycle time	180 nsec	—
T1	Address valid until IOCS16- is asserted	—	40 nsec
T2	Drive address (CS1FX-, CS3FX-, DA0, DA1 and DA2) valid before DIOR- or DIOW- setup	30 nsec	—
T3	IORDY setup time	—	—
T4	DIOW- or DIOR- pulse width (8-bit)	80 nsec	—
	DIOW- or DIOR- pulse width (16-bit)	80 nsec	—
T5	IORDY pulse width	—	—
T6	DIOW- data setup	30 nsec	—
T7	DIOR- data setup	20 nsec	—
T8	DIOR- data hold	5 nsec	—
T9	DIOW- data hold	15 nsec	—
T10	DIOW- or DIOR- to address valid hold	10 nsec	—
T11	Address valid until IOCS16- is negated	—	30 nsec

The drive operates at mode 1 multiword DMA timing specifications, as shown below.

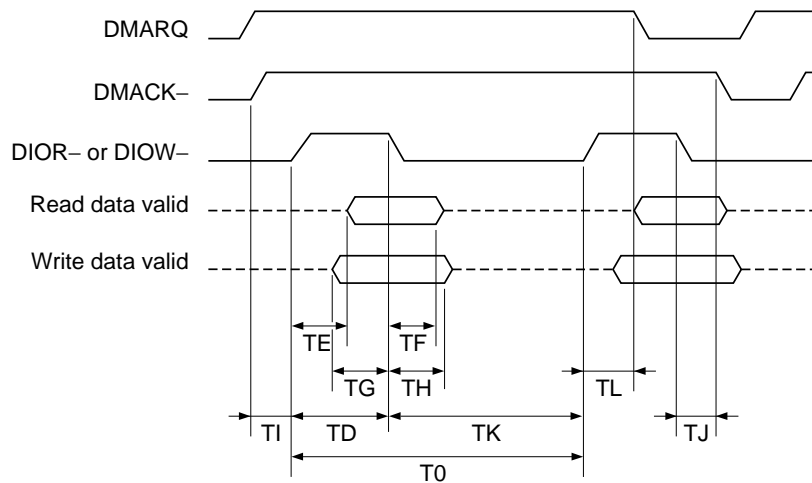
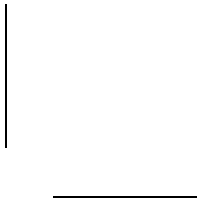
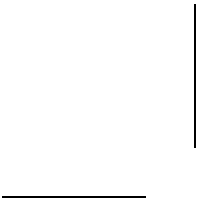
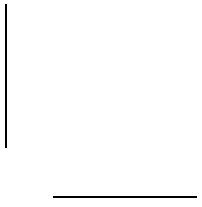
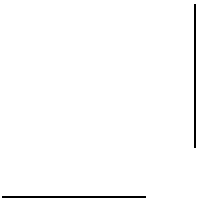

Figure 12. Multiword DMA timing

Time	Description	Min	Max
T ₀	Cycle time	180 nsec	—
T _D	DIOR- or DIOW- pulse width (16-bit)	80 nsec	—
T _E	DIOR- data access	—	60 nsec
T _F	DIOR- data hold	5 nsec	—
T _G	DIOR- data setup	30 nsec	—
T _H	DIOW- data hold	15 nsec	—
T _I	DMACK- to DIOR- or DIOW- setup	0 nsec	—
T _J	DIOR- or DIOW- to DMACK- hold	5 nsec	—
T _{K_R}	DIOR- negated pulse width	60 nsec	—
T _{K_W}	DIOW- negated pulse width	60 nsec	—
T _{L_R}	DIOR- to DMARQ delay	—	120 nsec
T _{L_W}	DIOW- to DMARQ delay	—	40 nsec







Seagate Technology, Inc.

920 Disc Drive, Scotts Valley, California 95066, USA

Publication Number: 36244-003, Rev. A, Printed in Thailand